

Go, your daughter will be well again.

Ages 3+

May 10, 2020 • Mark 7:24-37

Connect the dots.

A B C D E F G H I J K L M N O P Q R S T



Faith and Healing

A woman came to Jesus.



Help the woman get to Jesus.

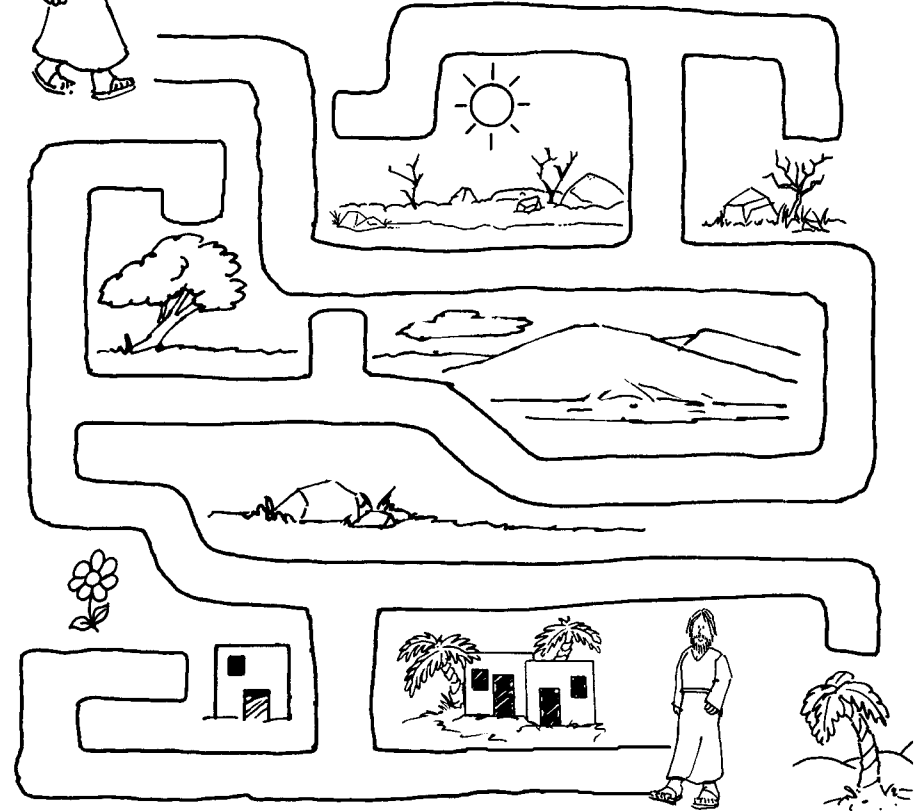

PIKE CREEK BIBLE CHURCH
Childrens Ministries
199 Polly Drummond Hill Road
Newark, DE 19711 302/731-7770

Enter your **SECRET CODE** to unlock games @
games.childrensbulletins.com

SECRET CODE
FGN204

She asked Jesus to heal her daughter.

Find and count how many
♥ hearts 3 or 4 ? 🦋 butterflies 4 or 5 ?



She had great faith in Jesus.

Shade the shapes that have ●●.

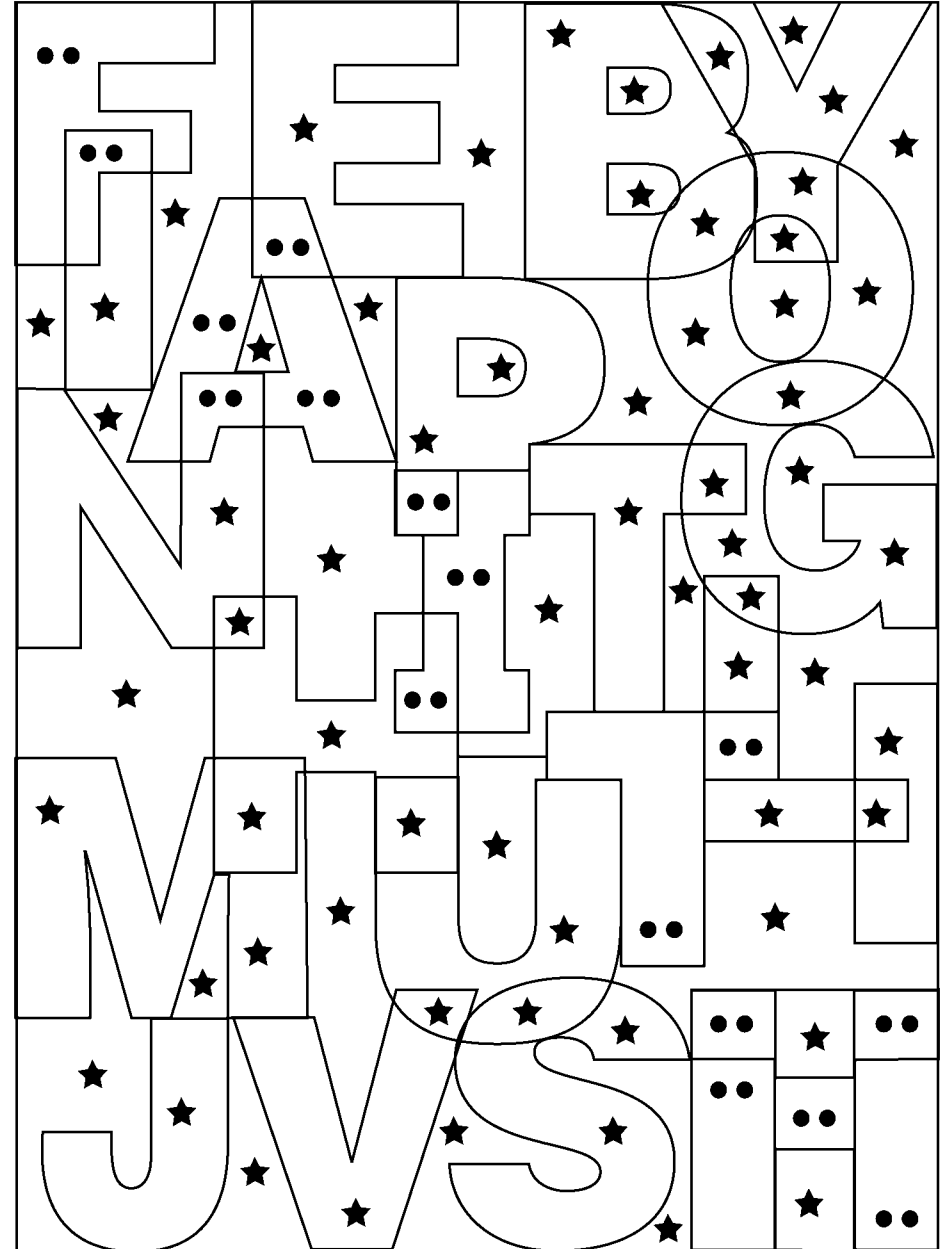

What happened next?

Use this code to find out.

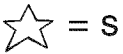
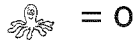
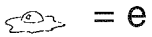
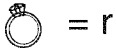
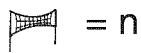
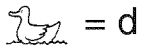
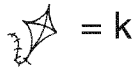
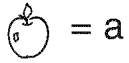

The man's _____



were _____ ,



and he began

to _____ .



Ages 3+

May 10, 2020 • Mark 7:24-37

Faith and Healing



A foreign woman begged Jesus to heal her sick daughter.

Help the woman get to Jesus through the crowd.

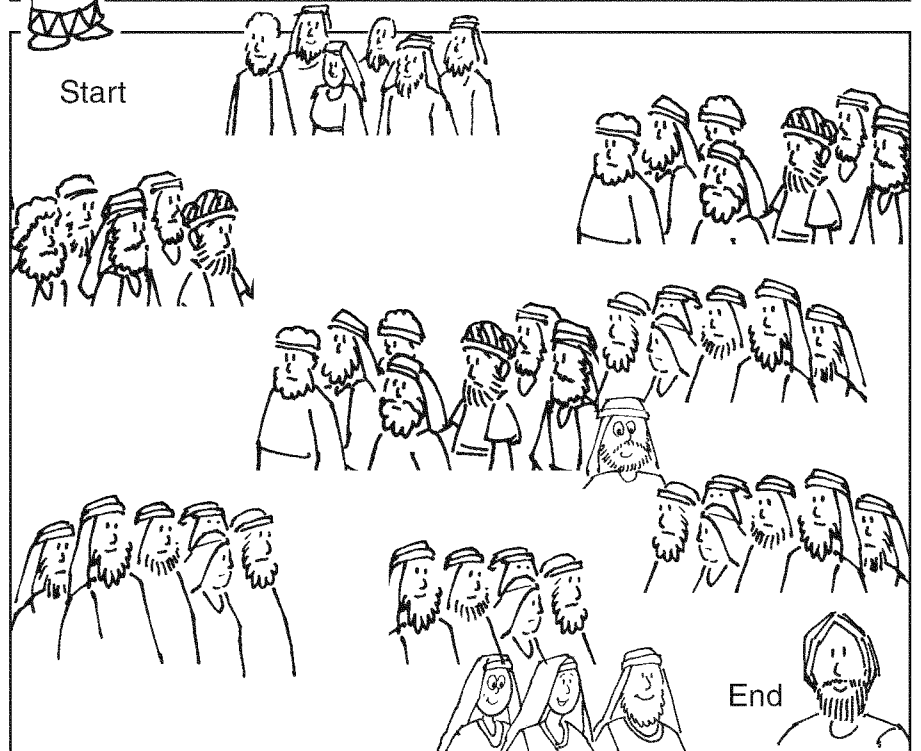

PIKE CREEK BIBLE CHURCH
 Childrens Ministries
 199 Polly Drummond Hill Road
 Newark, DE 19711 302/731-7770

Enter your **SECRET CODE** to unlock games @ games.childrensbulletins.com

SECRET CODE
JZJW72

The woman had great faith.
Jesus made her daughter well.

Find the hidden letters: F A I T H



A deaf man had faith in Jesus.
Jesus touched him and prayed.

Connect the dots.

ABCDEF GHIJKL MNOPQRS
1 2 3 4 5 6 7 8 9 10 11 12 13 14 15 16 17 18 19 20 21 22 23

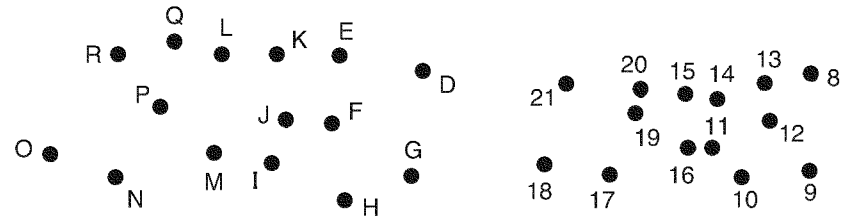
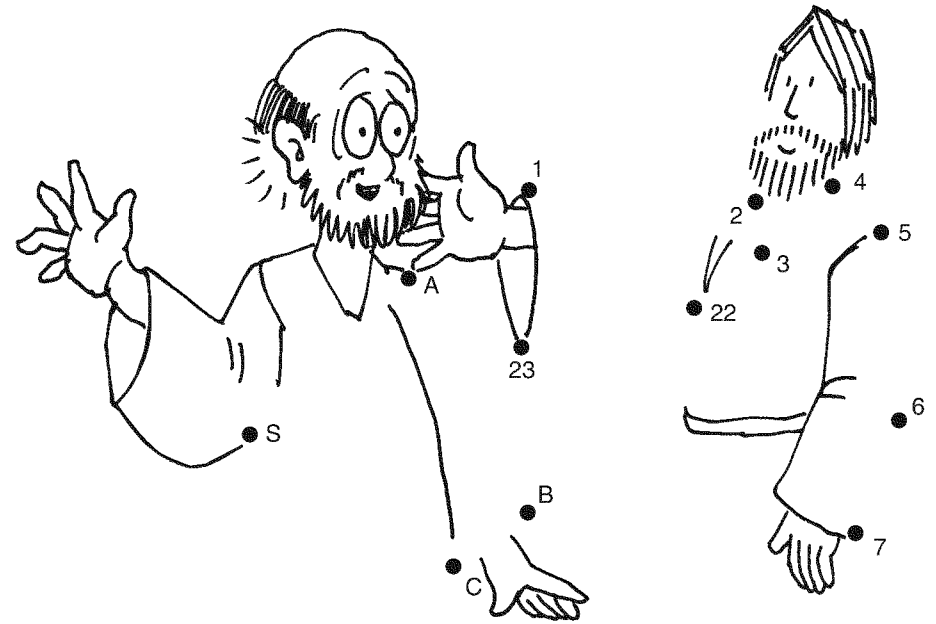

Jesus made the man well.

Trace the picture.

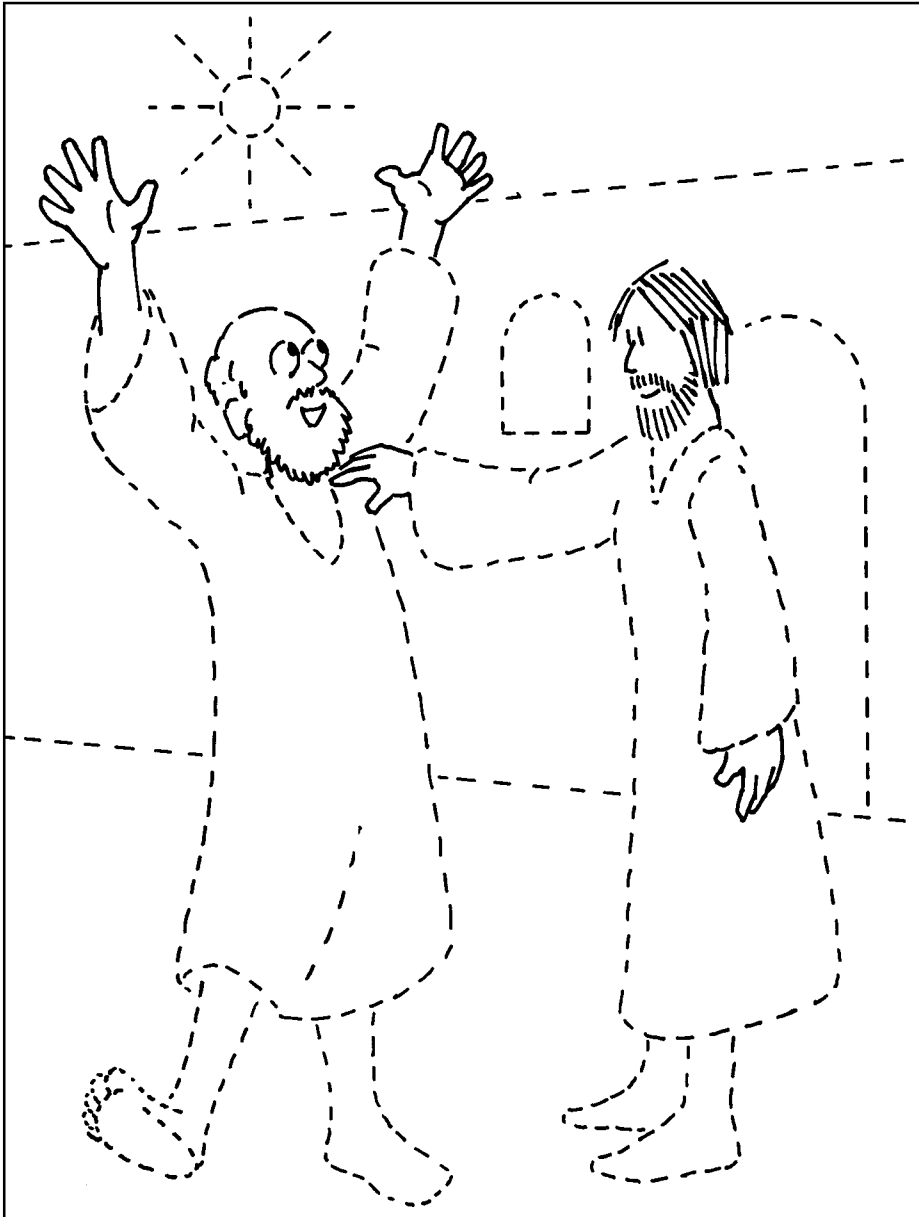

Ages 3+

May 17, 2020 • Mark 7:24-37

Faith and Healing

A woman came to Jesus for help.
She bowed at His feet.

Circle 10 things that are different in the bottom picture.

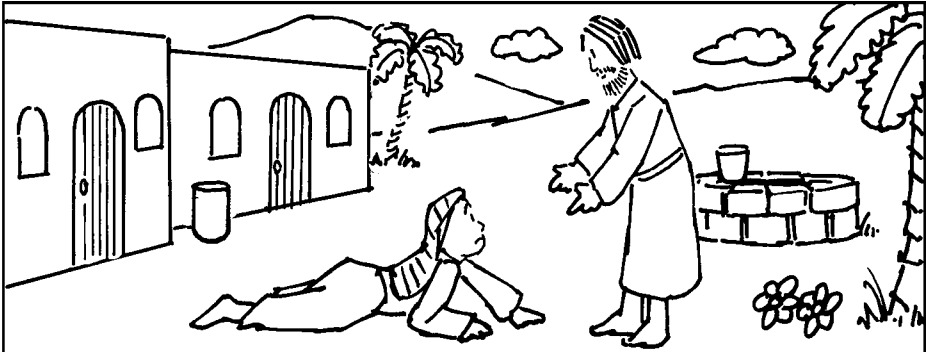
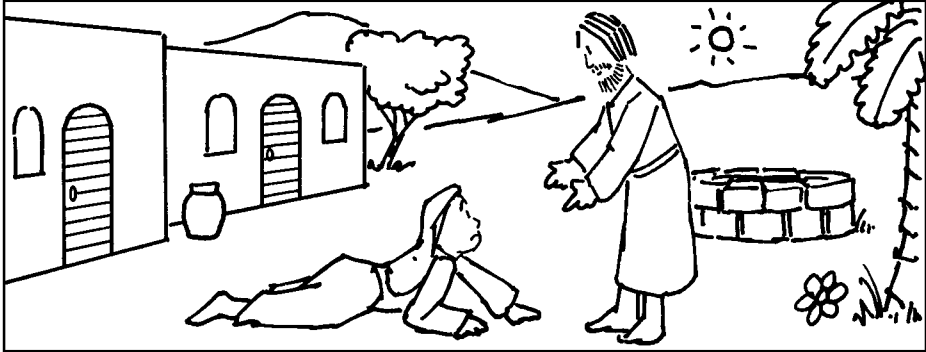

PIKE CREEK BIBLE CHURCH
Childrens Ministries
199 Polly Drummond Hill Road
Newark, DE 19711 302/731-7770

Enter your **SECRET CODE** to unlock games @ games.childrensbulletins.com **SECRET CODE**
WWFV69



The woman's daughter
was ill. She knew
only Jesus could
help her.



Follow the lines to the letters. Trace the letters.

She had

FAITH

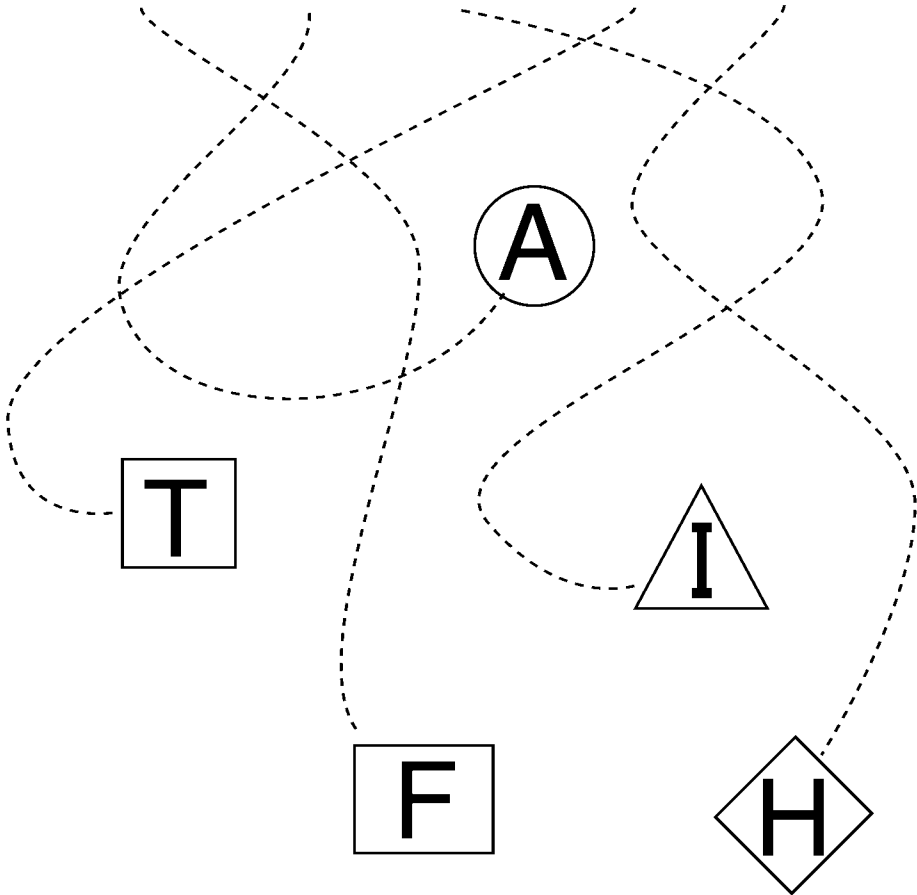

A man's friends took him to see Jesus for
help. The man could not hear or speak.

Help the man get to Jesus.

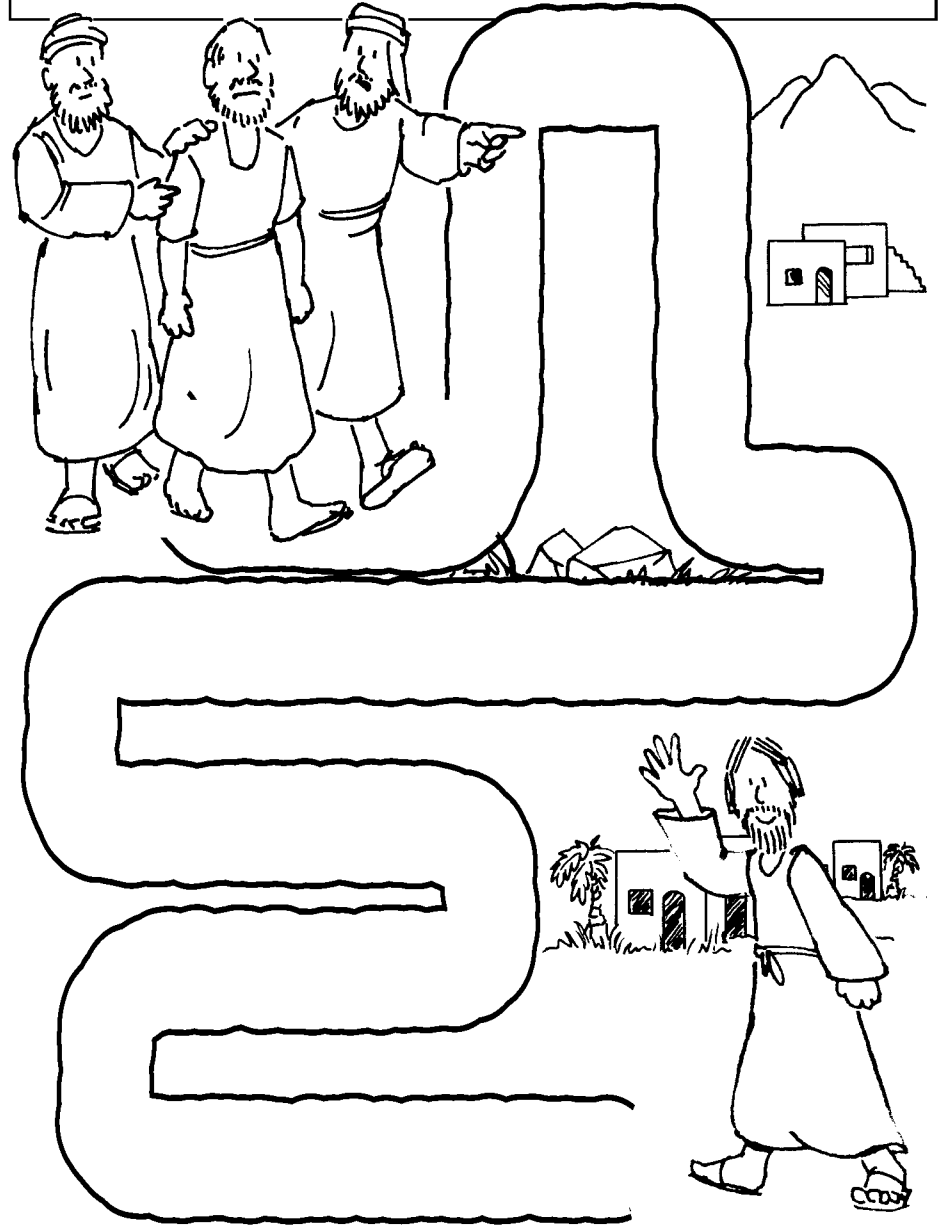

Jesus put His fingers into his ears.
 Jesus touched the man's tongue and said,
 "Be opened!" The man was healed!

Put the pictures in the correct order.

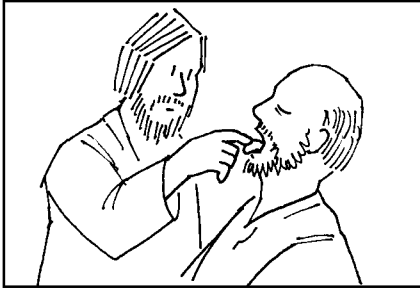

1

2

3

4

Ages 3+

May 17, 2020 • Mark 7:24-37

Jesus Heals a Girl and a Man

A woman begged Jesus
 to heal her daughter.

Circle the 1 picture that is different.



PIKE CREEK BIBLE CHURCH
 Childrens Ministries
 199 Polly Drummond Hill Road
 Newark, DE 19711 302/731-7770

Enter your **SECRET CODE** to unlock games @
games.childrensbulletins.com

SECRET CODE
VQJR01

Jesus told the woman to go home.
 The woman did so.
 Her daughter had been healed!

Match the puzzle pieces. Write the letters.

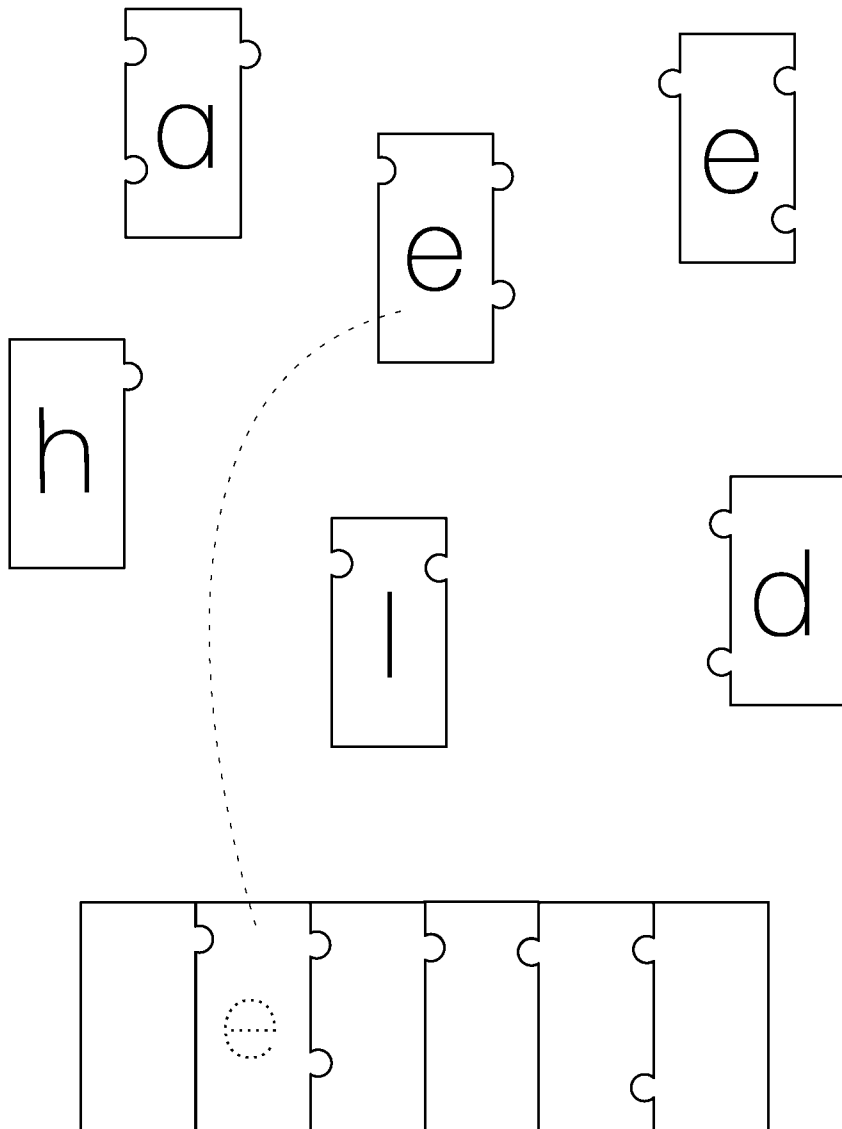

Some people brought a man to Jesus.
 The man could not hear or speak.

Follow the number maze. 1 2 3 4 5 6 7 8 9 10 11 12

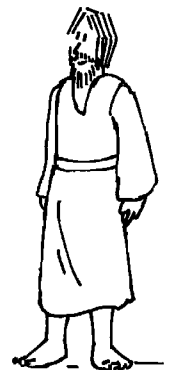
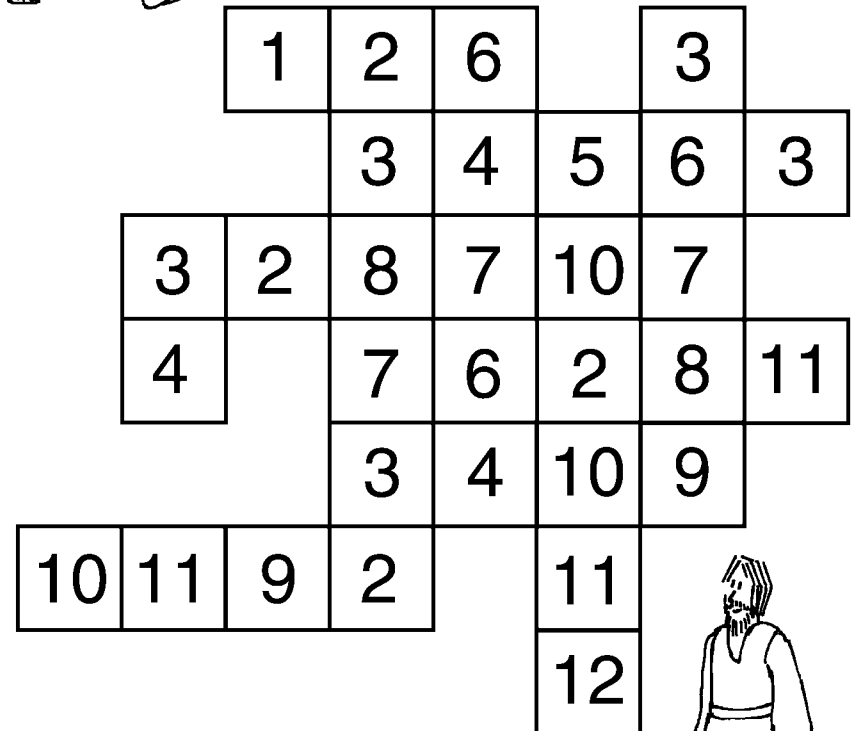

The man could hear and speak!

Find the hidden objects in the picture.



Ages 3+

May 24, 2020 • Mark 7:31-37

Jesus Heals a Man

Some people brought a man to Jesus. The man could not hear or speak. They asked Jesus to heal him.

Help the friends bring the man to Jesus.

1 2 3 4 5 6 7 8 9

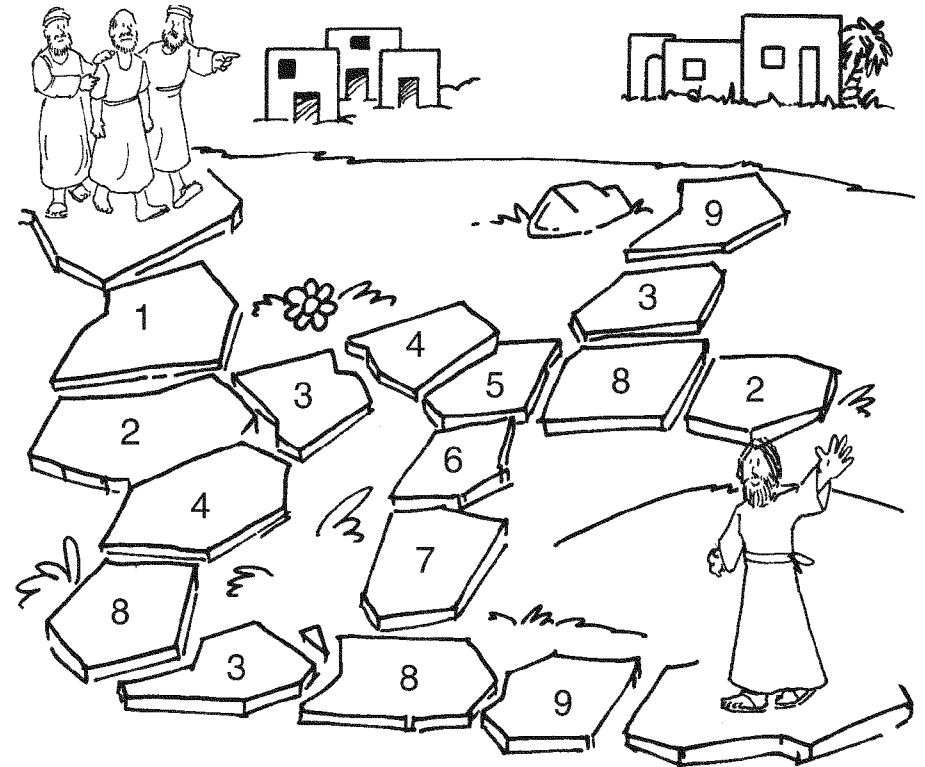

PIKE CREEK BIBLE CHURCH
 Childrens Ministries
 199 Polly Drummond Hill Road
 Newark, DE 19711 302/731-7770

Enter your **SECRET CODE** to unlock games @
games.childrensbulletins.com

SECRET CODE
ECZP63

Jesus put His fingers into the man's ears.
He touched the man's tongue.

Circle 6 differences in the 2nd picture.

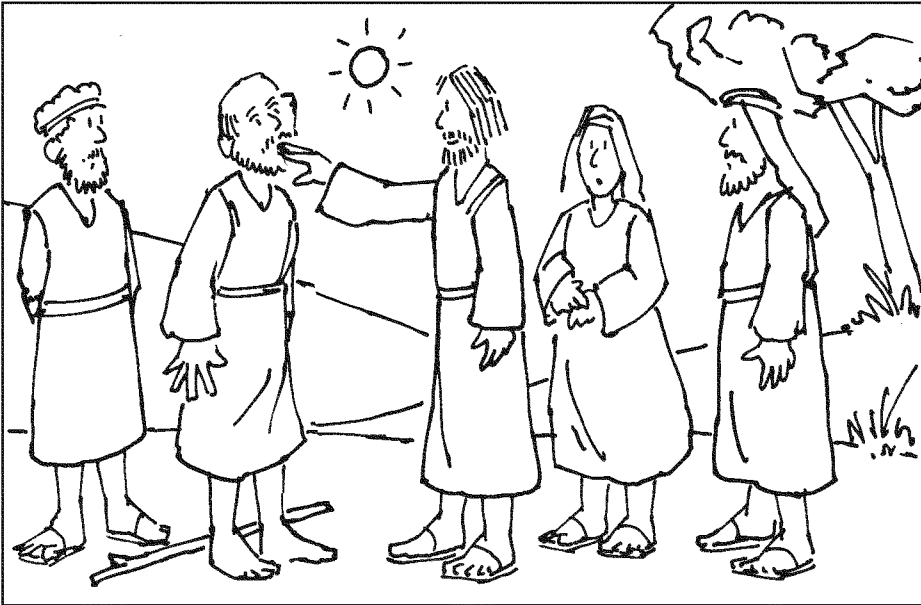
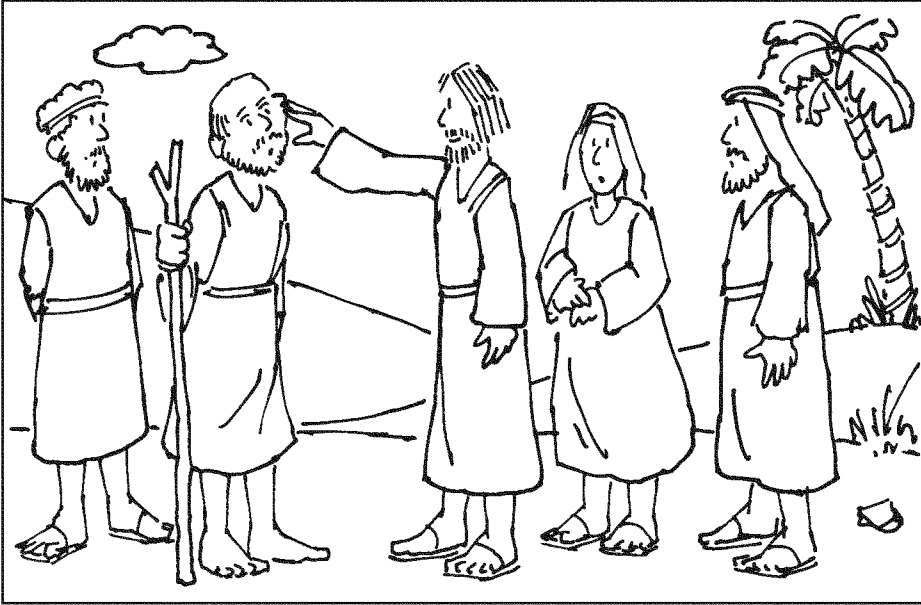

Jesus looked to heaven and spoke aloud.
What did Jesus say?

Use the code to fill in the missing letters.

ear = e door = d box = o envelope = p nose = n



“B _____ !”
ear box envelope ear nose ear door

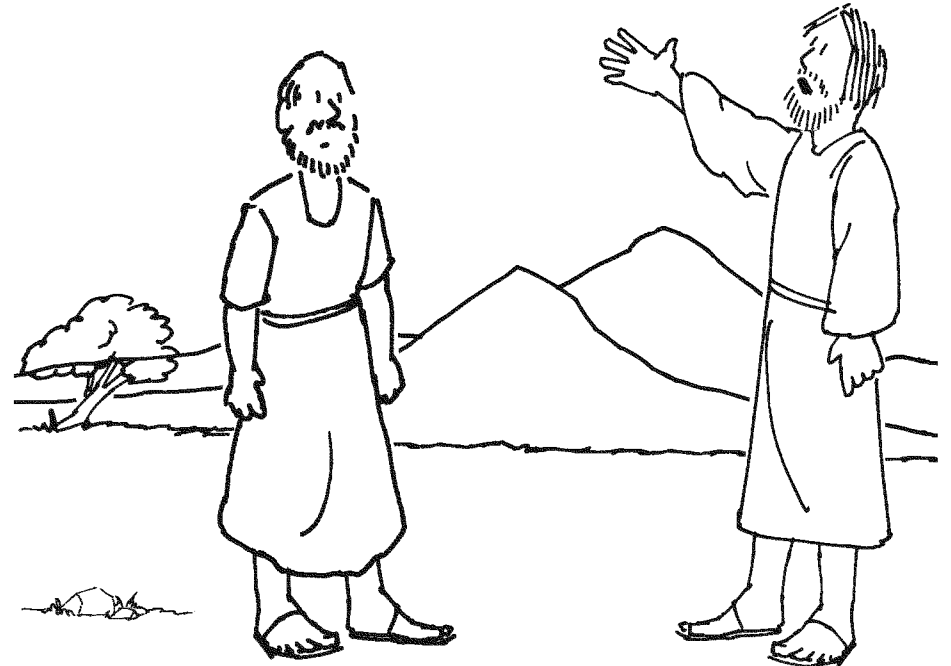

The man's ears were opened, and he began to speak plainly. The people were overwhelmed with amazement.

Circle 5 differences in the bottom picture.

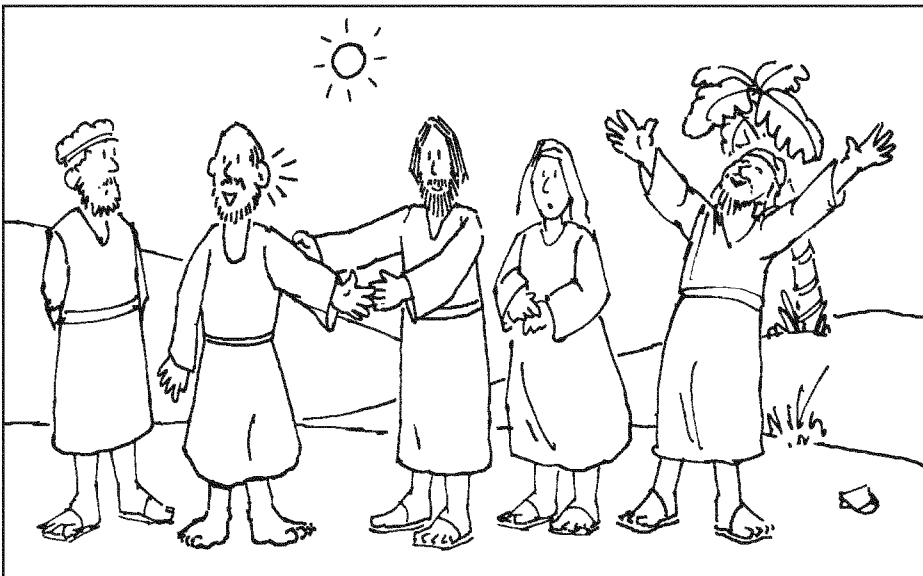
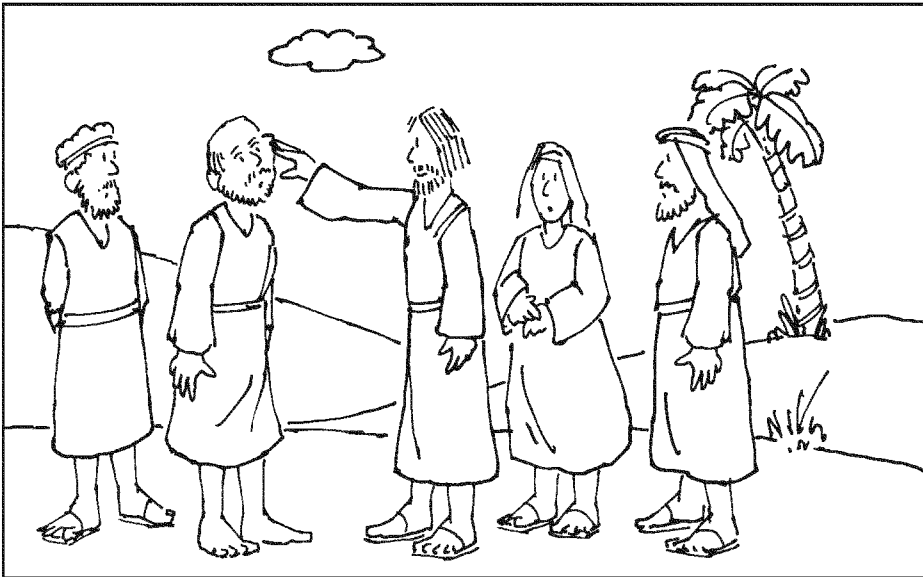

Ages 3+

May 24, 2020 • Mark 7:31-37

Jesus Heals a Deaf Man

Jesus went down to the Sea of Galilee.

Circle the picture of Jesus near the sea.

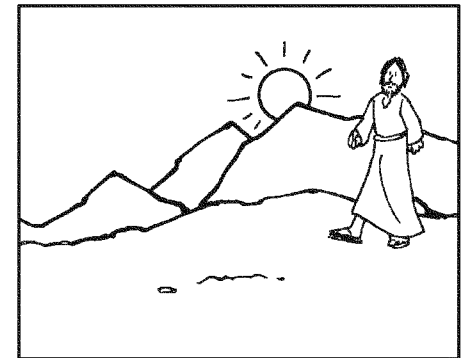
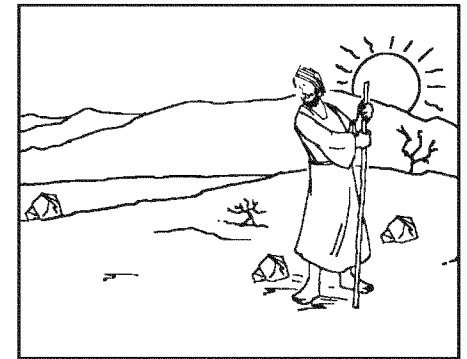

PIKE CREEK BIBLE CHURCH
Childrens Ministries
199 Polly Drummond Hill Road
Newark, DE 19711 302/731-7770

Enter your **SECRET CODE** to unlock games @
games.childrensbulletins.com

SECRET CODE
JWZV72

Some people brought a man to Jesus.
The man was deaf and could hardly talk.

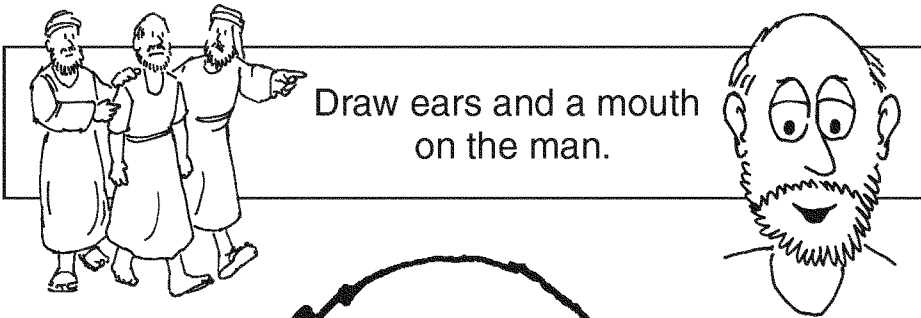







Draw ears and a mouth
on the man.



Jesus put His fingers into the man's ears.
Then He spit and touched the man's tongue.

Use the code to fill in the letters.

 = B	 = d	 = e
 = n	 = o	 = p

Jesus looked up to heaven
and said,



“



!”





Jesus commanded the people not to tell anyone about what He had done. But they did! People were overwhelmed with amazement.

Write the letter missing from each set on the line.

They said,

“He has everything .”

CEF MNP LMO CDF UVX DFG JKM KMN

He even makes the

CEF DFG YZB EGH

 and the

FGI CDF ZBC QST

 ”

LNO STV RSU DFG QRT NOQ CDF YZB IJL

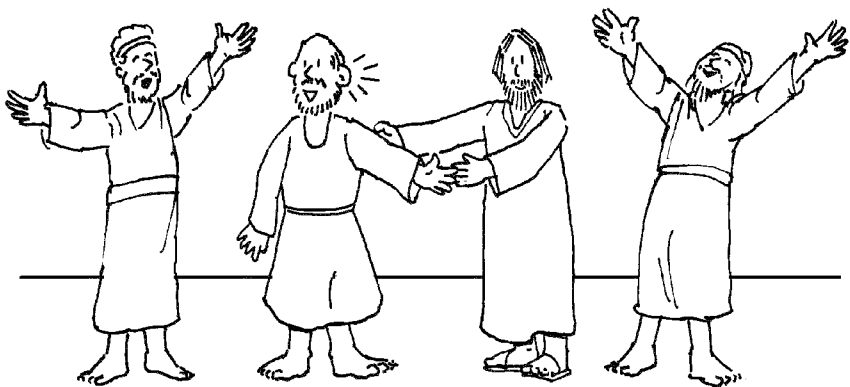

Ages 7+

May 10, 2020 • Mark 7:24-37

Faith and Healing

A woman fell at Jesus' feet.

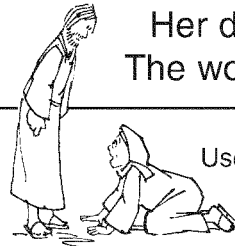

Her daughter was possessed by an evil spirit. The woman begged Jesus to heal her daughter.

Use the puzzle below to find out what happened next. Cross out the first letter and every other letter after. (We have done the first 2 for you.) Then copy the remaining letters to the lines below and read the rest of the story.

~~g~~S~~p~~hmenbkenltiservweydbtwhmaptnJbecsdufskcporu
wlc~~v~~hteslw~~p~~bhzekr~~n~~SghqeqhrawddfcabintwhpJyeds
kujsqs~~b~~acwdhfegrh~~f~~jakiltmhn~~a~~p~~n~~qdrstevnwtytz~~h~~ceb~~d~~
wermjok~~n~~howuttqoc~~f~~dhbez~~r~~qlyirt~~b~~tdlfejgqiwr~~m~~l.

S h _____



PIKE CREEK BIBLE CHURCH
Childrens Ministries
199 Polly Drummond Hill Road
Newark, DE 19711 302/731-7770

Enter your **SECRET CODE** to unlock games @ **SECRET CODE**
games.childrensbulletins.com **QTRT58**

Fit the words in the puzzle. Transfer the letters to the story.

- | | |
|-------|---------|
| man | crowd |
| put | speak |
| deaf | people |
| talk | hardly |
| hand | begged |
| took | tongue |
| away | looked |
| man's | heaven |
| ears | opened |
| spit | brought |
| said | fingers |
| Jesus | plainly |
| could | touched |
| place | |

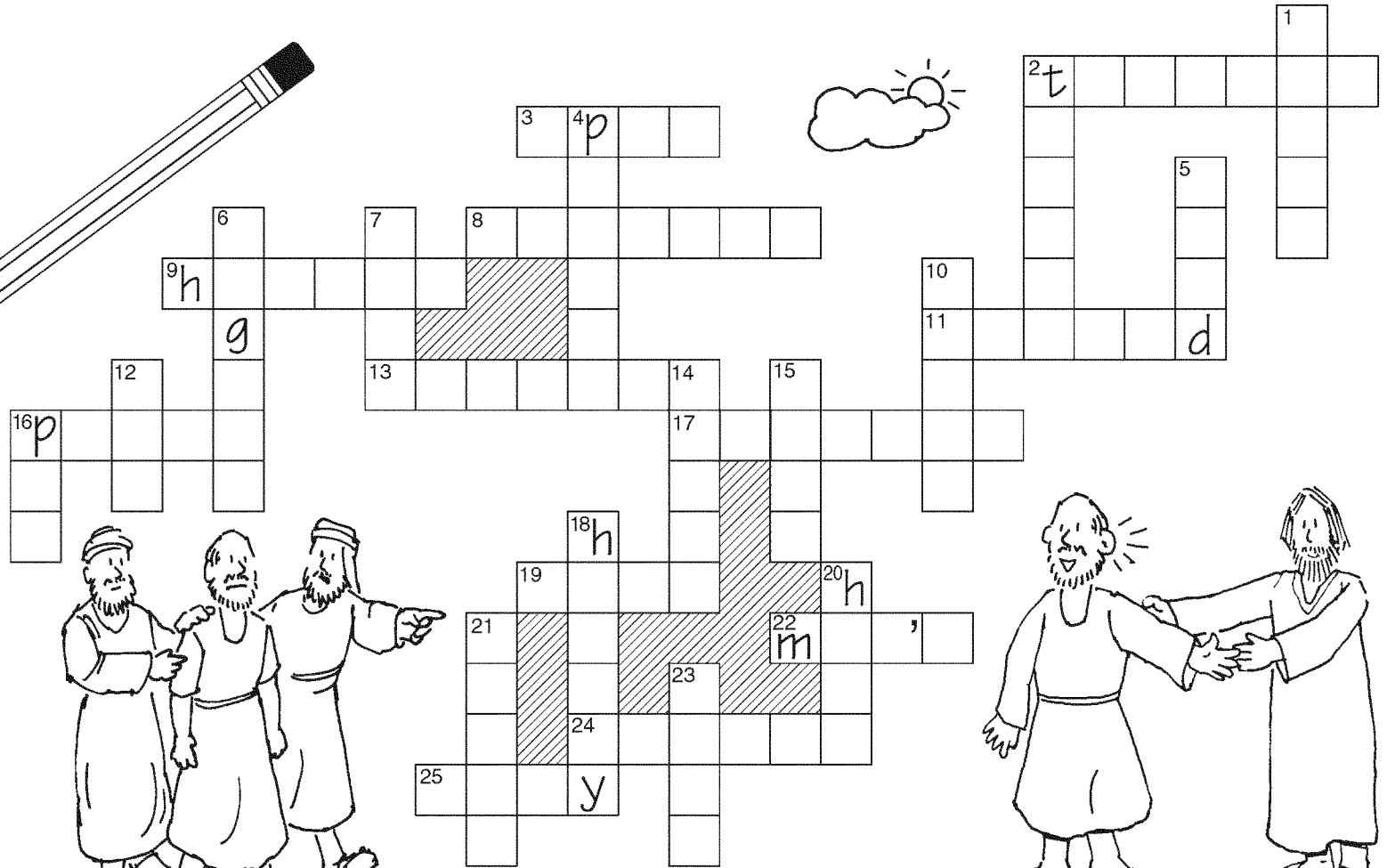
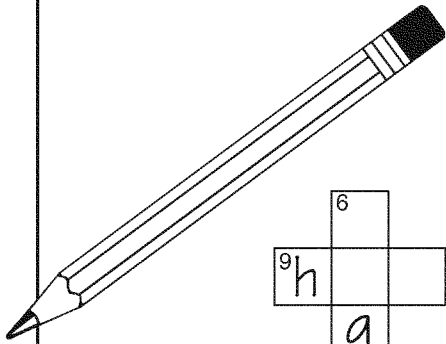

Some 4) _____ 8) _____ a 12) _____ to 1) _____ who was 7) _____ and 10) _____
 18) _____ 19) _____. They 6) _____ Him to 16A) _____ His 20) _____ on the 12) _____.
 He 23) _____ the 12) _____ 25) _____ from the 21) _____ and 16D) _____ His 13) _____ into the
 22) _____ ' 15) _____. Then He 3) _____ and 2A) _____ the 22) _____ ' 2D) _____.
 He 24) _____ to 9) _____ and 5) _____, "Be 11) _____!" The 22) _____ ' 15) _____ were
 11) _____ and he 10) _____ 14) _____ 17) _____.



What did the people say about Jesus?

Add the numbers from the intersecting row and column to fill in the blanks below.

	0	1	2	3	4	5	6	7	8	9	10	11
1	L	A	M	H	K	D	N	W	E	U	T	S
2	A	M	H	K	D	N	W	E	U	T	S	V
3	M	H	K	D	N	W	E	U	T	S	V	Y
4	H	K	D	N	W	E	U	T	S	V	Y	R
5	K	D	N	W	E	U	T	S	V	Y	R	P
6	D	N	W	E	U	T	S	V	Y	R	P	O
7	N	W	E	U	T	S	V	Y	R	P	O	G
8	W	E	U	T	S	V	Y	R	P	O	G	I

People were overwhelmed with amazement.

“ H e h a s _____
 4 9 4 2 12 6 17 7 9

9 13 9 15 14 11 4 19 7 18
 _____,” they said.

8 9 1 1

“ 4 9 9 13 9 7 3 2 5 9 12

11 4 9 6 9 2 4 9 2 15

2 7 6 11 4 9 3 10 11 9

12 16 9 2 5

Jesus Heals a Girl and a Man

A woman begged Jesus to drive a demon out of her daughter. Jesus said, “It is not right to take the children’s bread and toss it to their dogs.” How did the woman reply?

Finish the grid puzzle by drawing the mirror image of what is already shown. Unscramble the letters to fill in the blanks.

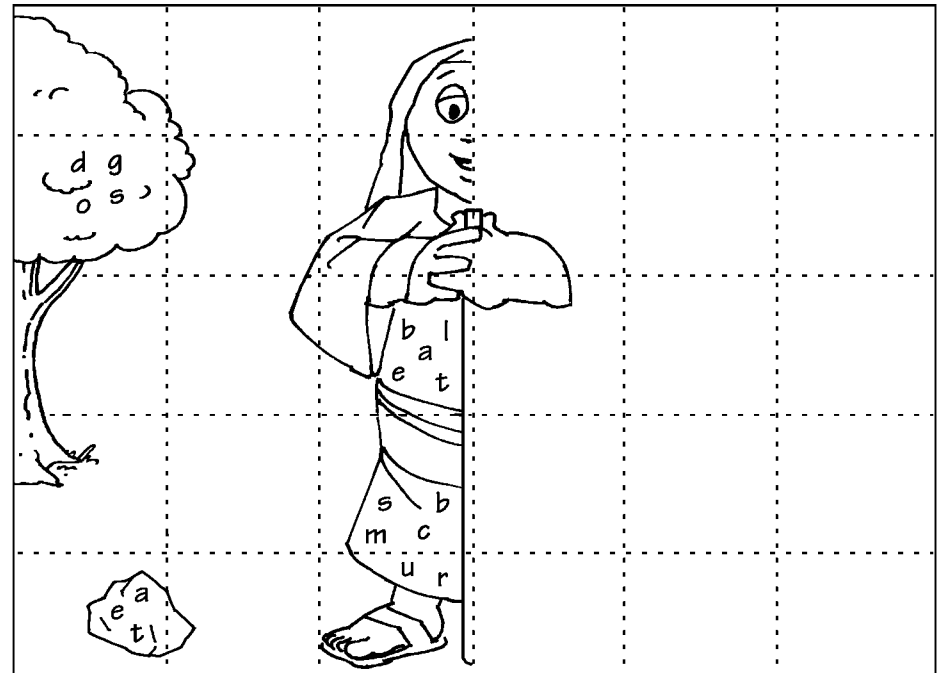

“Lord,” she replied, “even the _____ under the _____ the children’s _____.”



PIKE CREEK BIBLE CHURCH
 Childrens Ministries
 199 Polly Drummond Hill Road
 Newark, DE 19711 302/731-7770

Enter your **SECRET CODE** to unlock games @ games.childrensbulletins.com

SECRET CODE
BWCF75



Jesus replied to the woman,
 "For such a reply, you may go;
 the demon has left your daughter."
 What happened?

Use the code here to find the words.

••• A B C	••• D E F	••• G H I
••• J K L	••• M N O	••• P Q R
••• S T U	••• V W X	••• Y Z

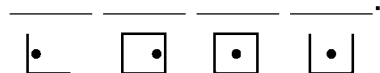
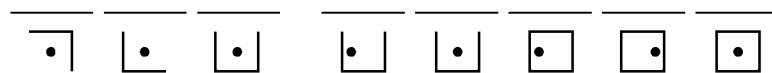
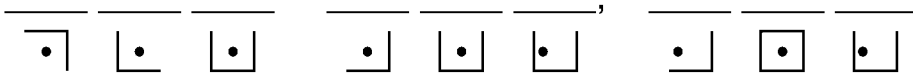
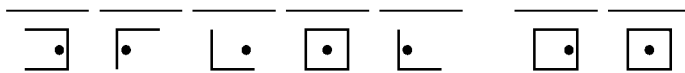
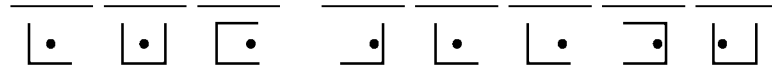
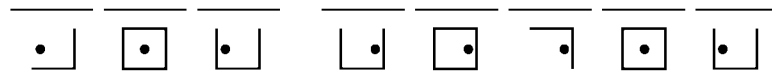
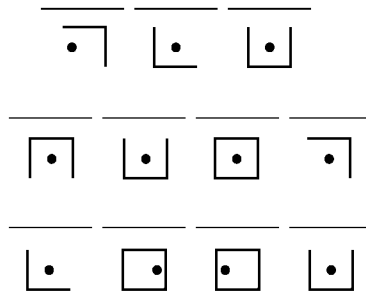

Some people brought to Jesus a man who could not hear and could hardly talk. Jesus touched the man and said, "Be opened!" What happened?

Unscramble the words to fill in the blanks.

A R E S
R A S

D L E O O
N S E D

B O E D
P E N

E E K P
S A

C E G T
O U N

F P A L
Y I L N

At this, the man's _____ were _____,

his _____ was _____

_____ and he

began to _____

_____.

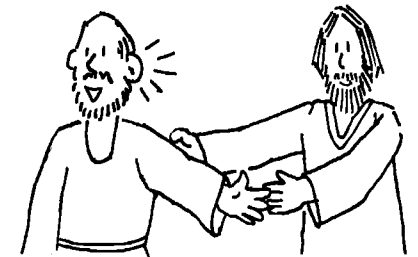

F

A woman who was a foreigner, and whose little daughter was possessed by an impure spirit, came and fell at Jesus' feet. She begged Jesus to drive the demon out of her daughter. What happened?

Use this chart to find the answer.

A	B	C	D	E	F	G	H	I	L	M	O	R	S	T	U	W
1	17	6	12	15	2	16	7	13	4	8	9	14	5	11	3	10

17 15 6 1 3 5 15

9 2 7 15 14

2 1 13 11 7

7 15 14

12 1 3 16 7 11 15 14

10 1 5 8 1 12 15

10 15 4 4!

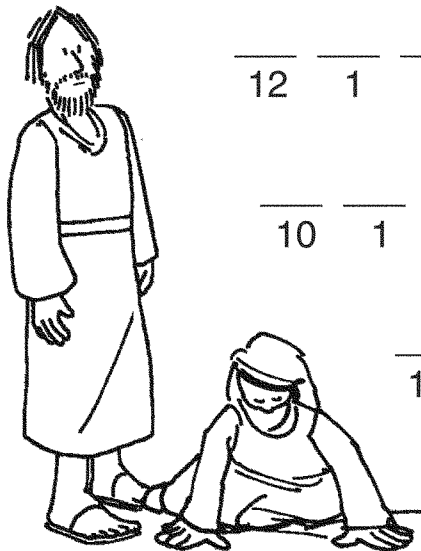

People brought a man to Jesus who could not hear and could hardly talk. They begged Jesus to place His hand on him. What did Jesus do?



Fit the letters into the words in the order given. Read what happened.



esustooteaasieeutisiesitea
seasTeesitatoueteastoue
esusooetoeaeeaaieoeTeaoueaaseaea

J_____ k _h_ m_n

____d_. H_ p____ H____ f_ng_r_

_n _h_ m_n'____r_. _h_n H_

_p____ _nd _____ch_d _h_ m_n'____

____ng____. J_____ l____k_d ____

h____v_n ____nd s____d, "B____p_n_d!"

____h_ m_n c____ld h____r ____nd

____p____k cl____rly!



The people couldn't keep quiet about what Jesus had done!



1	A	D	E	F
2	G	H	I	K
3	L	M	N	O
4	P	R	S	T
5	U	V	W	Y
6				
7				
8				
9				

They said ...

“
 2,7 1,8 2,7 1,6 4,8 1,7 3,9 3,8 1,8
 1,8 5,7 1,8 4,7 5,9 4,9 2,7 2,8 3,8 2,6
 5,8 1,8 3,6 3,6 2,7 1,8 1,8 5,7 1,8 3,8
 3,7 1,6 2,9 1,8 4,8 4,9 2,7 1,8
 1,7 1,8 1,6 1,9 2,7 1,8 1,6 4,7
 1,6 3,8 1,7 4,9 2,7 1,8 3,7 5,6 4,9 1,8
 4,8 4,6 1,8 1,6 2,9”

Faith and Healing

A Greek woman, born in Syrian Phoenicia, found Jesus when He came to Tyre. She knelt at Jesus' feet. She needed help. Why?

A	•-	J	•---	S	•••
B	•••	K	•-	T	-
C	•••	L	•••	U	••-
D	••	M	-	V	•••-
E	•	N	•-	W	••-
F	•••	O	---	X	•••-
G	•-	P	•••	Y	••-
H	•••	Q	••-	Z	•••-
I	••	R	••		

Use Morse Code to find what she did.



••• •••• • -••• • -•• -••• • -••
 •••• -••• •••• •••• -••••
 -••• -••• •••• •••• •••• -••••
 •••• •••• •••• •••• •••• ••••
 •••• •••• •••• •••• •••• ••••
 •••• •••• •••• •••• •••• ••••

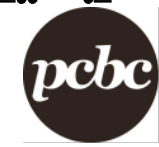

PIKE CREEK BIBLE CHURCH
 Childrens Ministries
 199 Polly Drummond Hill Road
 Newark, DE 19711 302/731-7770

Enter your **SECRET CODE** to unlock games @ games.childrensbulletins.com **SECRET CODE**
JHRT03

Jesus spoke with the woman and found that she was filled with humility and _____. He healed the woman's daughter.

To find the missing word, color in the boxes that are listed.

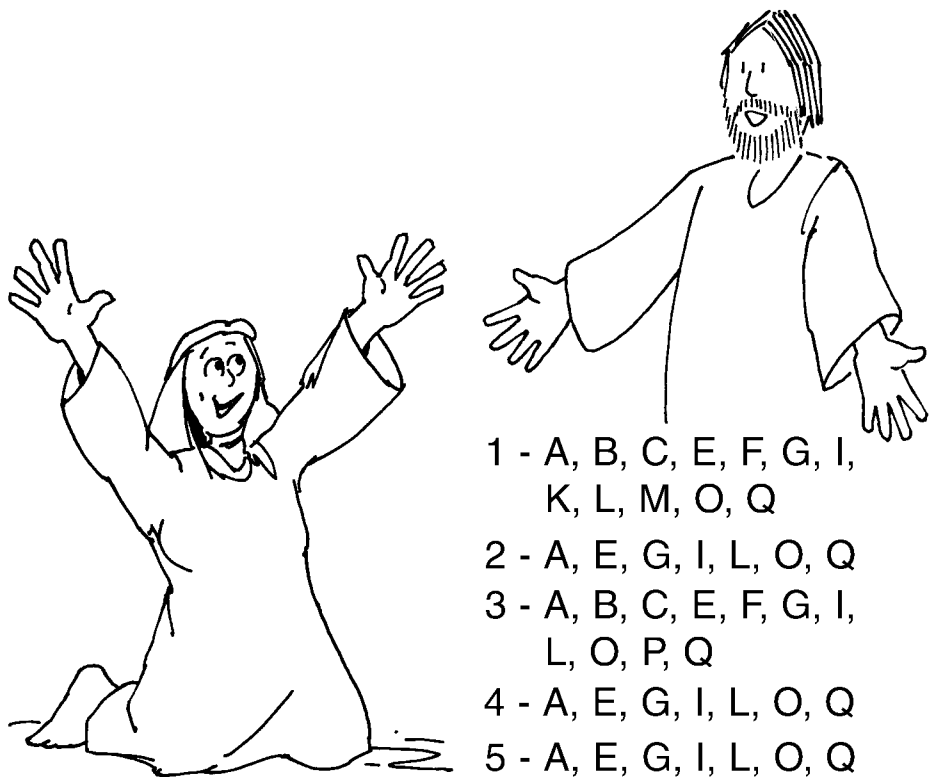

- 1 - A, B, C, E, F, G, I, K, L, M, O, Q
- 2 - A, E, G, I, L, O, Q
- 3 - A, B, C, E, F, G, I, L, O, P, Q
- 4 - A, E, G, I, L, O, Q
- 5 - A, E, G, I, L, O, Q
- 6 - A, E, G, I, L, O, Q

	A	B	C	D	E	F	G	H	I	J	K	L	M	N	O	P	Q
1																	
2																	
3																	
4																	
5																	
6																	

When Jesus left Tyre, He went into the region of Decapolis. Read what happened ...

Find the answer to each problem.
Read the story in the order of the answers.

They begged Jesus to put His hand on him. $1+2=$

The man's ears were opened, his tongue was loosened, $3 \times 3 =$

The man was deaf and could hardly talk. $4 \div 2 =$

Some people brought a man to Jesus. $10-9 =$

and he began to speak plainly. $5+5 =$

Then He spit and touched the man's tongue. $2 \times 3 =$

He put His fingers in the man's ears. $10-5 =$

Jesus took the man aside, away from the others. $8 \div 2 =$

Jesus looked to heaven and said "Ephphatha," $4+3 =$

which means, "Be opened!" $10-2 =$

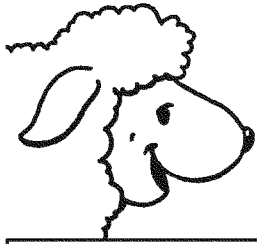

At this, the man's ears were opened, his tongue was loosened and he began to speak plainly. How did people feel about what Jesus had done?

Write the letter that is in the first word but not the second. Write the two words that are formed (reading top to bottom) on the blanks below.

- | | |
|-------------------------|----------------------|
| ① | ② |
| OPEN – PEN <u> 0 </u> | DEAF – FED _____ |
| SEVEN – SEEN _____ | TIME – TIE _____ |
| NAME – MAN _____ | SEAT – SET _____ |
| WEAR – AWE _____ | DOZEN – DONE _____ |
| WHERE – HERE _____ | AMBLE – LAMB _____ |
| HEART – TEAR _____ | HOMES – SHOE _____ |
| SEA – AS _____ | CARES – SCAR _____ |
| PLAIN – PAIN _____ | LOOSEN – LOOSE _____ |
| MERIT – TIRE _____ | STARE – EARS _____ |
| STEAM – MATS _____ | |
| DONE – EON _____ | |

People were 0
 with _____

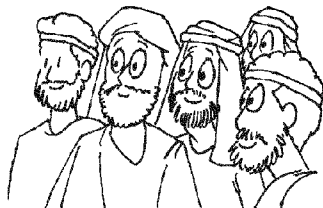

Jesus Heals a Man

Jesus left the vicinity of Tyre and went through Sidon to the Sea of Galilee and into the region of the Decapolis.

Find the underlined words in the puzzle. They are **↑ ↓ → ← ↶ ↷ ↸ ↹**.



PIKE CREEK BIBLE CHURCH
 Childrens Ministries
 199 Polly Drummond Hill Road
 Newark, DE 19711 302/731-7770

Enter your **SECRET CODE** to unlock games @ **games.childrensbulletins.com**

SECRET CODE
N00238

There some people brought to Him a man who was deaf and could hardly talk, and they begged Jesus to place His hand on him.

Help the crowd get to Jesus.

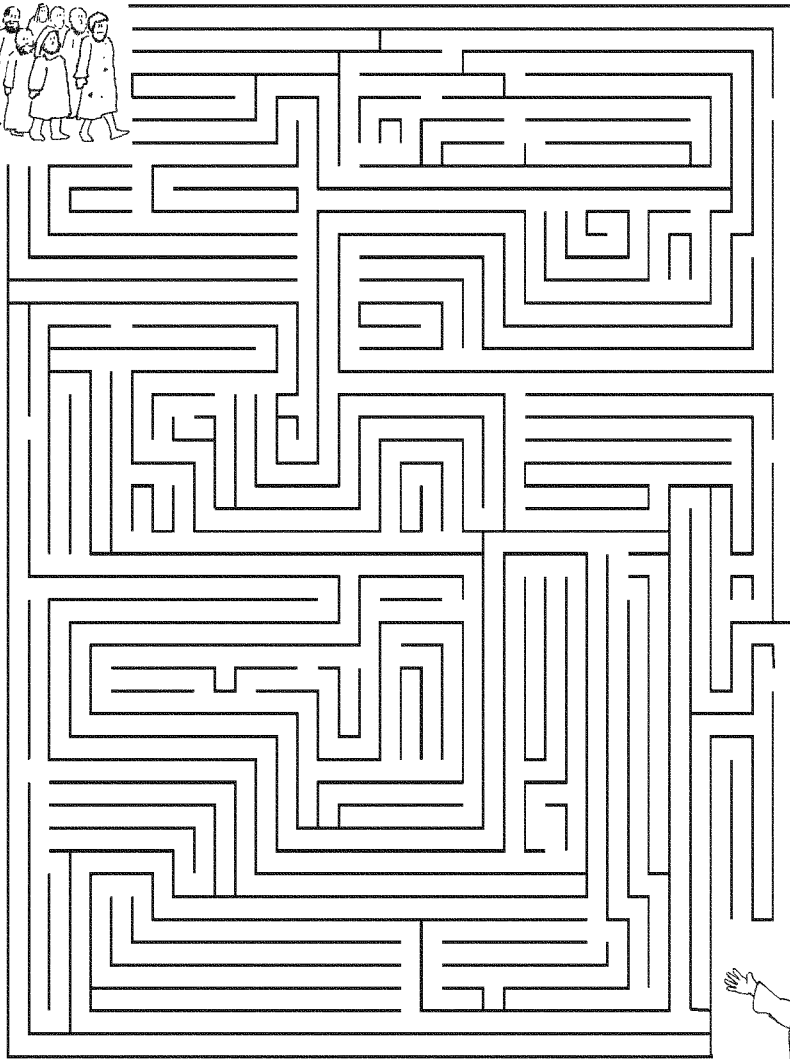
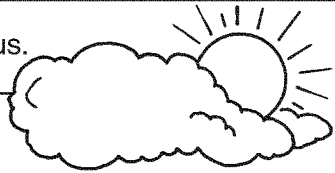

What did Jesus do? What did He say?

Find the answers by using the code.

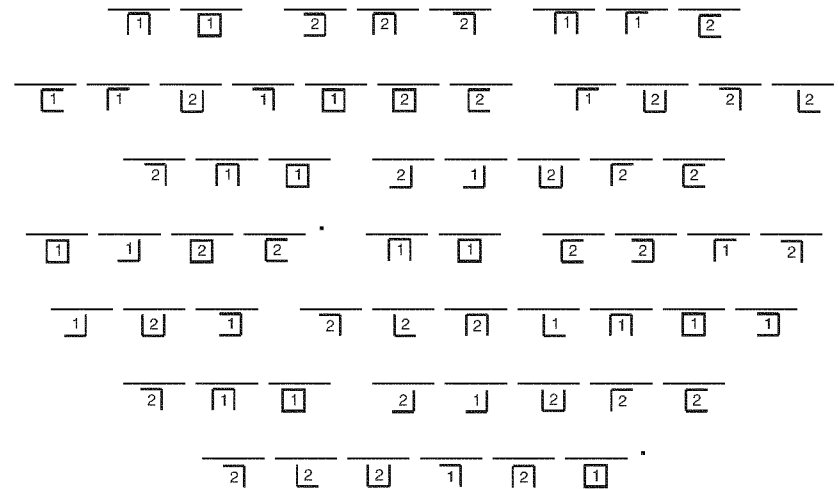
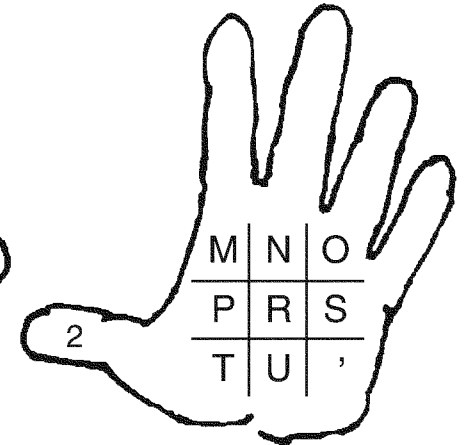
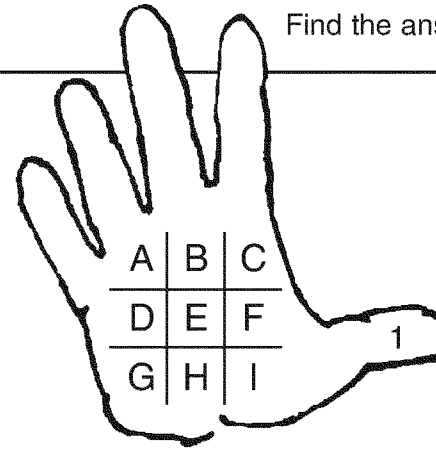

Jesus said . . .

“ 1 2 1 2 1 1 2 1 1 ”

which means

“ 1 1 2 2 1 2 1 1 ”



The people were amazed.

Follow the arrows and write the words below.
Start at the center dot.

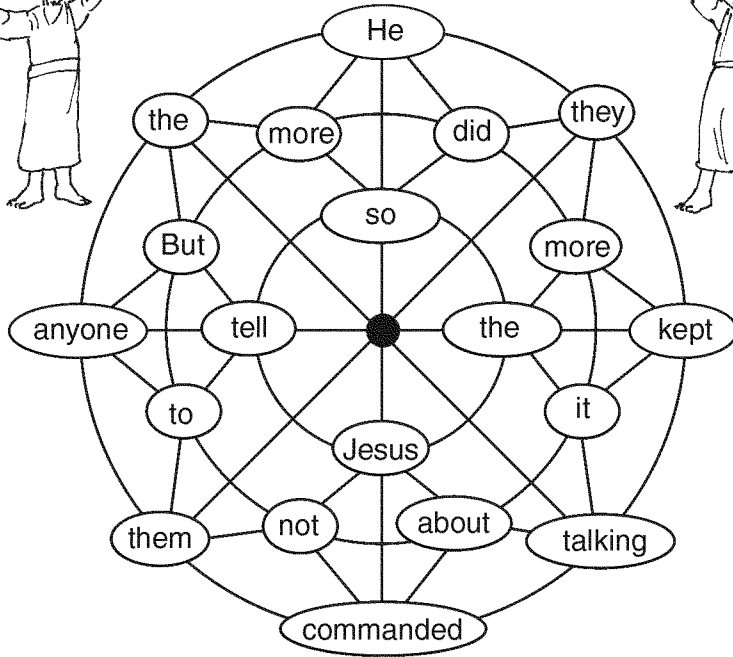

↓ ↓ ↶ ↷ ↶

↗ ← ↗ ↖ →

↗ ↘ ↘ ↘ ↗ ↖

↓ ↘ ↘ ← ↗

Jesus Heals a Deaf Man

Jesus went on a journey.

Find the correct path through the maze and write the words along the way in the blanks below.



Begin

	the	and	Tyre	safe
Jesus	of	of	tired	the
led	left	vicinity	lake	people
	mountain	down	and	of
to	Egypt	dust	desert	believed
the	stones	of	through	dry
hot	river	afraid	Sidon,	region
Sea	complained	and	went	Decapolis.
thirsty	and	sand	snakes	days.
sun	Galilee	and	into	the
the	walking	the	the	END



PIKE CREEK BIBLE CHURCH
 Childrens Ministries
 199 Polly Drummond Hill Road
 Newark, DE 19711 302/731-7770

Enter your **SECRET CODE** to unlock games @ games.childrensbulletins.com **SECRET CODE**
HJQCN2

Then what happened?

Fit the words in the list on the blanks and read the story.
Match each picture with its description.

Be	sigh	speak	tongue
away	spit	begged	fingers
deaf	talk	heaven	plainly
ears	crowd	opened	touched
hand	place	people	loosened

① Some _____ brought to Him
a man who was _____ and could hardly
t _____, and they _____ g _____
Him to _____ His
_____ on the man.

② After He took him aside, _____
from the _____,
Jesus put His _____
into the man's _____ s _____.

③ Then He _____ t _____ and
_____ the man's
_____.

④ He looked up to _____
and with a deep _____ g _____ said to him,
“Ephphatha!” (which means,
“ _____ !”).

⑤ At this, the man's ears were opened,
his tongue was _____
and he began to _____ k _____.



